

# LZTi

## HEAT PUMPS AIR/WATER

DC INVERTER COMPRESSOR WITH VAPOR INJECTION (EVI)

Heating power from 7 kW to 19 kW

R410A

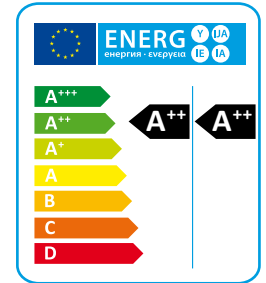

The LZTi series of high efficiency heat pumps has been specifically designed for use with radiant floor heating systems or those applications where it is necessary to have maximum efficiency when heating.

They have been optimized on heating mode, are able to produce water up to 65°C and can operate down to -20°C ambient temperature.

LZTi units are available in 2 or 4 pipe (SW6) versions. Both versions can produce domestic hot water, in the standard LZTi through the activation of an external 3-way-valve and in the SW6 version by means of a separate heat exchanger and hydraulic circuit for the domestic hot water.

All models are supplied as standard with a reversing valve for defrost and cold water production in summer.

### VERSIONS

**STD** 2 pipes reversible standard.

**SW6** 4 pipes unit capable of producing hot and cold water at the same time on two independent hydraulic circuits.

LZTi - LZTi/SW6		09	11	16	21
Heating capacity (EN14511) <sup>(1)</sup>	kW	7,7	9,6	15,0	19,0
Total input power (EN14511) <sup>(1)</sup>	kW	1,8	2,3	3,4	4,5
COP (EN14511) <sup>(1)</sup>	W/W	4,28	4,17	4,41	4,22
Energy Class in low temperature <sup>(2)</sup>		A++	A++	A++	A++
SCOP low temperature <sup>(2)</sup>	kWh/ kWh	4,05	4,08	4,27	4,16
ns,h low temperature <sup>(2)</sup>	%	153,8	155,8	157,3	157,8
Energy Class in medium temperature <sup>(2)</sup>		A+	A+	A++	A++
SCOP medium temperature <sup>(2)</sup>	kWh/ kWh	3,39	3,46	3,61	3,54
ηs,h medium temperature <sup>(2)</sup>	%	132,0	135,0	142,0	139,0
Cooling capacity (EN14511) <sup>(3)</sup>	kW	7,1	8,5	13,5	16,0
Total input power (EN14511) <sup>(3)</sup>	kW	2,3	2,8	4,2	5,1
EER (EN14511) <sup>(3)</sup>	W/W	3,10	3,04	3,21	3,14
Power supply	V/Ph/Hz	230/1/50	230/1/50	400/3+N/50	400/3+N/50
Max input current standard unit	A	21,9	21,9	15,8	15,8
Peak current standard unit	A	31,0	31,0	22,8	22,8
Fans	n°	1	1	2	2
Compressors	n°	1 E.VI. DC inverter	1 E.VI. DC inverter	1 E.VI. DC inverter	1 E.VI. DC inverter
Global warming potential (GWP)		2088	2088	2088	2088
Refrigerant charge	kg	3,3	3,3	4,3	4,3
Equivalent CO <sub>2</sub> charge	t	6,9	6,9	9,0	9,0
Sound power <sup>(4)</sup>	dB (A)	68	68	74	74
Sound pressure <sup>(5)</sup>	dB (A)	40	40	46	46

Performances are referred to the following conditions:

(1) Heating: Ambient temperature 7°C DB, 6°C WB, water temperature 30/35°C.

(2) Average conditions, low temperature, variable - Reg EU 811/2013.

(3) Cooling: ambient temperature 35°C, water temperature 12/7°C.

(4) Sound power level in accordance with ISO 3744.

(5) Sound pressure level at 10 mt from the unit in free field conditions in accordance with ISO 3744.

## COMPONENTS

### FRAME

All units are made from hot-galvanised sheet steel, painted with polyurethane powder enamel and stoved at 180°C to provide maximum protection against corrosion. The frame is self-supporting with removable panels. All screws and rivets used are made from stainless steel.

The standard colour of the units is RAL9018.

### REFRIGERANT CIRCUIT

The refrigerant circuit is made by using components from leading international companies in accordance with ISO 97/23 for the of braze welding processes.

The refrigerant used is R410A.

The refrigerant circuit includes: sight glass, filter drier, electronic expansion valve, 4-way valve, check valves, liquid receiver, Schrader valves for maintenance and control, a safety device (according to PED regulation).

The units are also equipped with plate heat exchanger AISI316 used as economizer circuit and additional thermostatic steam injection.

### COMPRESSORS

The compressors are high-efficiency scroll type, variable-speed modulation capability through DC inverter, supplied with a special design that increases the efficiency of the refrigeration cycle under conditions of very low ambient temperature.

The units are equipped with an economizer and a steam injection system, a versatile method to improve the capacity and efficiency of the system.

The technology of steam injection, consists into injecting the refrigerant vapor in the middle of the compression process, to increase significantly the capabilities and efficiencies too.

The compressors are equipped with an innovative electric motor permanent magnet brushless DC inverter-driven, high-efficiency, are all equipped with electrical resistance and thermal overload protection.

### SOURCE HEAT EXCHANGER

The source heat exchanger is made from 3/8" copper pipes and 0,1mm thick aluminium fins with the tubes being mechanically expanded into the aluminium fins in order to maximise heat transfer. Furthermore, the design guarantees a low air side pressure drop thus enabling the use of low rotation speed (and hence low noise) fans.

### USER HEAT EXCHANGERS

The user heat exchanger is a braze welded, plate type heat exchanger, manufactured from AISI 316 stainless steel. Utilisation of this type of exchanger results in a massive reduction of the refrigerant charge of the unit compared to a traditional shell-in-tube type. A further advantage is a reduction in the overall dimensions of the unit.

The exchangers are factory insulated with flexible close cell material and can be fitted with an antifreeze heater (accessory). Each exchanger is fitted with a temperature sensor on the discharge water side for antifreeze protection.

### HIGH EFFICIENCY AXIAL FANS

High efficiency E.C. axial fans, supplied with Brushless DC electric motors electronically commutated (E.C. motors) able to grants the highest energy efficiency class, according to the latest EU specifications, with the result of substantial energy consumption reduction for ventilation and noise reduction thanks to the new ultra efficient blade profiling. The fans are statically and dynamically balanced and supplied complete with a safety fan guard complying with the requirements of EN 60335. The fans are installed using a special steel profiled beam who minimize all vibrations transmitted to the frame and can modulate their speed till very low values, reducing in this way the electrical consumptions and the noise level during most of their operation. On all units we can control evaporating/condensing pressure by reading the pressure transducer and the continuous modulation of the EC fans rotation speed. The motors have a moisture protection rating of IP 54.

**MICROPROCESSORS**

All units are supplied as standard with microprocessor controls. The microprocessor controls the following functions: control of the water temperature, antifreeze protection, compressor timing, compressor automatic starting sequence (For multiple compressors), alarm reset. The control panel is supplied with display showing all operational icons. The microprocessor is set for automatic defrost (when operating in severe ambient conditions) and for summer/ winter change over.

The control also manages the anti-legionella program, the integration with other heating sources (electric heaters, boilers, solar panels etc), the operation of a three port modulating valve (for diverting to DHW or heating) and both the heating circuit pump and the domestic hot water circuit pump. If required (available as an option), the microprocessor can be configured in order for it to connect to a site BMS system thus enabling remote control and management. The Hidros technical department can discuss and evaluate, in conjunction with the customer, solutions using MODBUS protocols.

**ELECTRIC ENCLOSURE**

The enclosure is manufactured in order to comply with the requirements of the electromagnetic compatibility standards CEE EN60204. Access to the enclosure is achieved by removing the front panel of the unit. The following components are supplied as standard on all units: main switch, a sequence relay that disables the power supply in the event that the phase sequence is incorrect (scroll compressors can be damaged if they rotate in the wrong direction), thermal overloads (protection of pumps and fans), compressor fuses, control circuit automatic breakers, compressor contactors, fan contactors and pump contactors. The terminal board has volt free contacts for remote ON-OFF, Summer/ winter change over (heat pumps only) and general alarm.

**CONTROL AND PROTECTION DEVICES**

All units are supplied with the following controls and protections: user water return temperature sensor, antifreeze protection temperature sensor installed on users water output, domestic hot water supply and return temperature sensors (only versions SW6), high pressure manual reset, low pressure automatic reset, compressor thermal protection, air fan, thermal protection, pressure transducer (used to optimize the defrost cycle and to adjust the fan speed depending on ambient conditions), flow switch. All units are also fitted with a temperature probe sensor with "Energy Saving" function, supplied in a separate plastic box, which can be used to stop the pump use during periods of stand-by, when the water temperature reaches the set point. Doing this the power consumption of the unit is strongly reduced.

**NOISE REDUCTION**

All units are supplied, as standard, with the latest 'Floating Frame' technology that completely isolates the compressors from the main casing, thereby eliminating vibration and noise from this source. The 'Floating Frame' is a special vibration and acoustic damping system that consists of a base plate and acoustic enclosure that houses the compressors. The base plate is separated from the supporting frame of the unit by soft steel springs that have a high damping power. Within the enclosure, the compressors are mounted on rubber shock absorbers on the floating base plate. The enclosure is manufactured from galvanized steel sandwich panels that have a micro-perforated inner skin and a core of 30 mm thick, high density (25 kg/m<sup>3</sup>). The entire arrangement provides a double damping system and acoustic attenuation. The compressor refrigerant pipes are connected to the refrigerant circuit through "anaconda" flexible connections. Flexible connections are also used on the water pipework within the unit. The combination of these systems results in an overall noise reduction in the region of 6-8 dB(A).

**VERSIONS**

**Unit with independent domestic hot water production (SW6)**

This version is fitted with an additional heat exchanger, used as condenser, to produce domestic hot water irrespective of the operation mode of the unit. The activation of the additional heat exchanger is performed automatically by the microprocessor control when the domestic hot water temperature, measured by the sensor, is lower than the required set point. If, during the summer months, the unit is operating on cooling, this version can produce hot and cold water simultaneously. This version is equipped with return and supply domestic hot water sensors and an advanced control panel with specific software for management of the system priorities.

**OPERATION LIMITS**

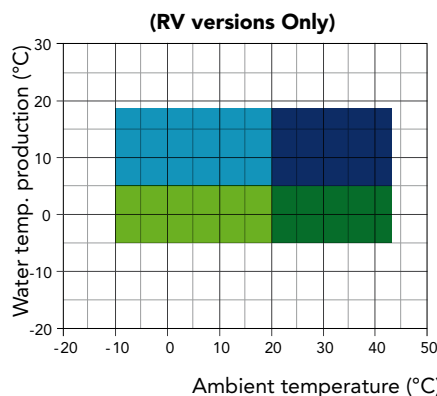
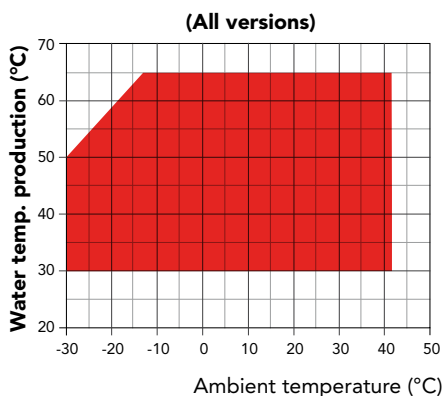

- Heating mode
- Cooling with head pressure control
- Cooling mode
- Cooling with head pressure control and glycol
- Cooling with glycol

## VERSIONS

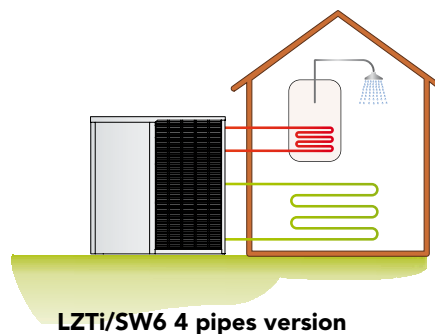
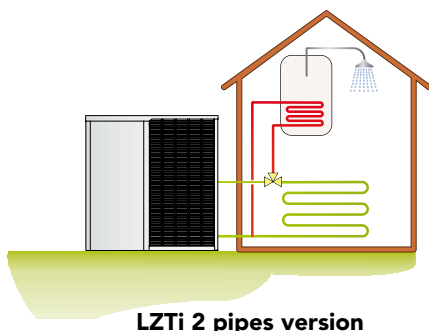

LZTi - LZTi/SW6		09	11	16	21
Main switch		●	●	●	●
Compressor automatic switch		●	●	●	●
Flow switch		●	●	●	●
Fans regulation by phase cut	DCCF	●	●	●	●
Fresh air temperature probe for set-point compensation	SOND	●	●	●	●
Specific software for operation priorities		●	●	●	●
Remote ON/OFF digital input		●	●	●	●
Summer/Winter digital input		●	●	●	●
Floating frame technology		●	●	●	●
Condensate discharge drip tray with antifreeze heater	BRCA	●	●	●	●
Electronic Expansion Valve	VTEE	●	●	●	●
Electronic Soft starter	DSSE	●	●	●	●
Remotable control panel		●	●	●	●
High efficiency fans		●	●	●	●
E1NT Hydraulic kit (pump only)	E1NT	○	○	○	○
Rubber anti-vibration mountings.	KAVG	○	○	○	○
Antifreeze kit	RAES	○	○	○	○
Serial interface card RS485 with MODBUS protocol	INSE	●	●	●	●

● Standard, ○ Optional, – Not available.

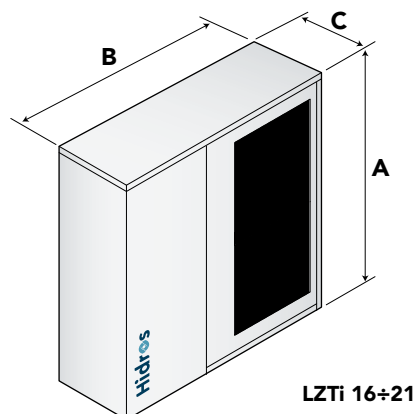
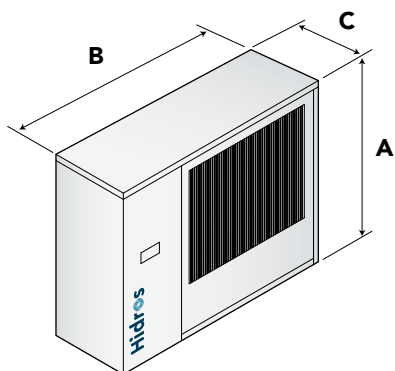

Mod.	A (mm)	B (mm)	C (mm)	kg
<b>09</b>	1250	1370	555	180
<b>11</b>	1250	1370	555	180

Mod.	A (mm)	B (mm)	C (mm)	kg
<b>16</b>	1450	1600	555	212
<b>21</b>	1450	1600	555	212